

flexiguide

Product Specification

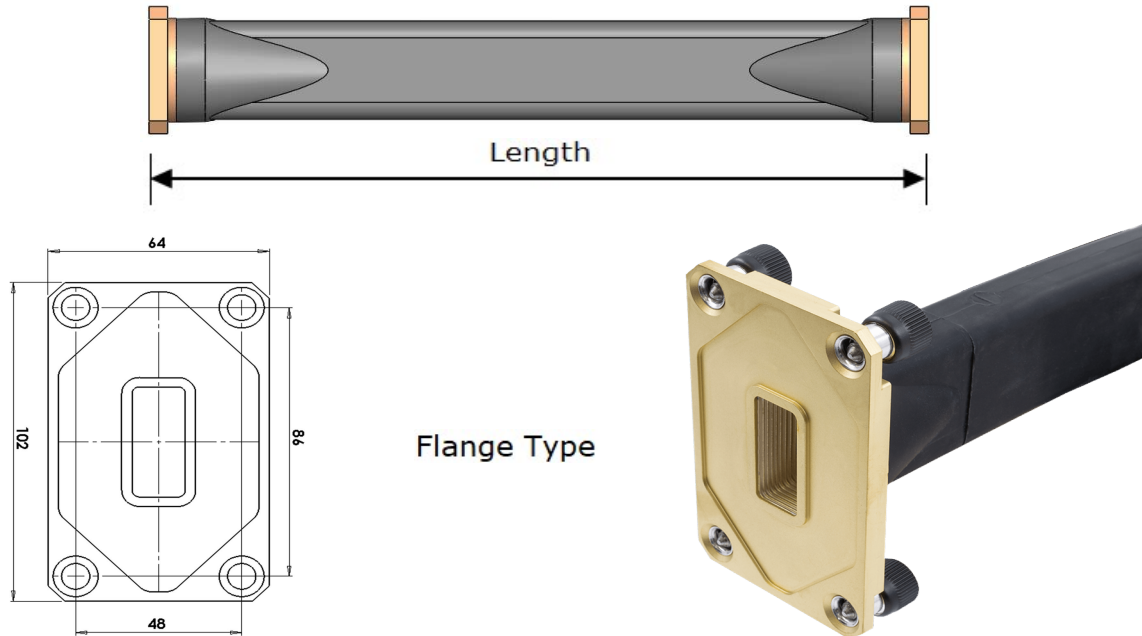

Part Number:

FT14-0785

Description

Product Type:	Flexible Twistable Waveguide
Waveguide Size:	WG14 / WR137 / R70
Flange Type (Both Ends):	C Band Quick Release (Male)
Length:	3000 mm / 118.1 inches
Length Tolerance:	+/- 1.5% or +/- 2 mm which ever is the greater
Flange Material / Plating:	Brass / No Plating
Accessories:	Hand Operated Screws

Mechanical Specifications

Jacket Material:	Silicone Rubber
Core Material:	Silver Plated Brass
Max. Recommended Operating Pressure:	10 psi / 0.7 kg/cm ²
Min. E-Plane Bend Radius (Static):	100 mm / 3.9 inches
Min. H-Plane Bend Radius (Static):	200 mm / 7.9 inches
Maximum Twist (Static):	210 Deg/m or 64 Deg/ft
Min. E-Plane Bend Radius (Repeated):	400 mm / 15.7 inches
Min. H-Plane Bend Radius (Repeated):	800 mm / 31.5 inches
Maximum Twist (Repeated):	52 Deg/m or 15.8 Deg/ft

Electrical Specifications

Frequency Range:	5.85 - 8.20 GHz
Insertion Loss:	0.84 dB Maximum
Return Loss:	23.3 dB Minimum
Peak Power:	560 kW Maximum
Average Power:	2 kW Maximum

Environmental Performance

Temperature Range:	-70 to +150°C
UV Resistance:	Excellent
Ozone Resistance:	Excellent
I.P. Rating:	IP68
Salt Mist:	BS EN 60068-2-52 (Method Kb - Extreme Marine Environments)